

Article number: 0101061
 Description: Retaining ring A 44 DIN 471
 Spring steel
 Note: Fitted with ZGA pilers

Measures

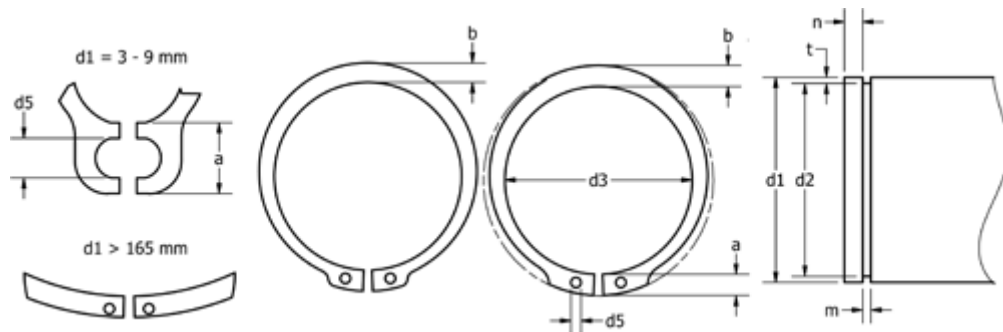

a max	= 6.6	FN kN	= 28.0	s	= 1.75
AN mm ²	= 168.0	FRg kN	= 9.20	t	= 1.25
b	= 4.6	FR kN	= 48.50	tol	= -0.25
d1	= 44	g	= 2.0	tol	= -0.06
d2	= 41.5	K kN-mm	= 90.70	tol	= +0,39-0,90
d3	= 40.5	m min	= 1.85	Tong	= ZGA-3
d5 min	= 2.5	n abl x 1000	= 12.0	Weight kg/1000	= 7.000
Description	= A44	Nominal drive	= 3.8		